

www.ersatzteil-service.de

www.ersatzteilplan.de

Modello n. IB-2750
IB-2755

Serie: dal n. 1001

Stampato n. P5090140

IBEA

LISTA RICAMBI

SPARE PART LIST

ERSATZTEILLISTE

LISTE DES PIECES DE RECHANGE



TURBO 70

Ihr Ersatzteilspezialist im Internet

REF. N°	PART. N°	QTY	DESCRIZIONE	DESCRIPTION	DESCRIPTION	BESCHREIBUNG
1	P5140309	1	DECALCO	DECAL	MARQUAGE	AUFKLEBER
2	P5140310	1	DECALCO	DECAL	MARQUAGE	AUFKLEBER
3	P5140015	1	DECALCO	DECAL	MARQUAGE	AUFKLEBER
4	P5140308	1	DECALCO	DECAL	MARQUAGE	AUFKLEBER
5	P5140199	1	DECALCO	DECAL	MARQUAGE	AUFKLEBER
6	P5140201	1	DECALCO	DECAL	MARQUAGE	AUFKLEBER
*	P5110008	1	CHIAVE	KEY	CLEF	SCHLÜSSEL
*	P5090137	1	MANUALE ISTRUZIONI	INSTRUCTION MANUAL	MODE D'EMPLOI	BEDIENUNGSANLEITUNG



Vor arbeiten am gerät zündkerzenstecker abziehen.
Sack nicht anfahren oder öffnen, so lange maschine laut.
Vor dem betrieb saugöffnung verschließen oder fangsaur-
zen und fangrohr sowie fangsack montieren.

Avant d'allumer le travail à la machine, retirez l'
câble d'allumage.

Ne retirez ou n'ouvrez pas le sac avant l'immob-
lisation du moteur.

Fermez l'ouverture d'admission ou montez une pièce de raccordement et un tub-
d'aspiration. Avant utilisation, fixez le sac à l'éjection.

Rimuovere la candela prima di qualsiasi intervento di manutenzione o riparazione.
Non rimuovere o aprire il castello prima che il motore si è arrestato.

Chiudere l'apertura di entrata o montare il tubo di aspirazione ed il cestello prim-
di adoperare la macchina.

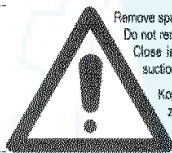

Remove spark plug lead prior to working on unit.
Do not remove or open bag prior to stopping engine.
Close inlet opening or assemble connecting piece and
suction tube and fasten bag on chute prior to operation

Koppel de ontstekingskabel los vooraleer U werk-
zaamheden aan de machine verricht.

Verwijder of open de bak niet vooraleer U de
motor hebt stopgezet.

Sluit de inlaatopening of monteer het tussstuk en de aanzuigtube en sluit de lin-
nen bak voor het gebruik.

Avant d'allumer le travail à la machine, retirez le câble d'allumage.

Ne retirez ou n'ouvrez pas le sac avant l'immobilisation du moteur.

Fermez l'ouverture d'admission ou montez une pièce de raccordement et un tub-
d'aspiration. Avant utilisation, fixez le sac à l'éjection.

5



1



2



Attrezzo in movimento. L'attrezzo continua a
rotare dopo che il motore viene spento.

Umlaufendes werkzeug. Werkzeug läuft
nach!

Tool in motion. Tool continues to
rotate after engine is switched off!

Outil de travail en mouvement. L'outil de travail continue de tour-
ner après que le moteur été coupé.

Het werktuig blijft roteren nadat de motor werd afgezet.

6



3

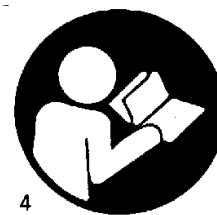

4

REF. N°	PART. N°	QTY	DESCRIZIONE	DESCRIPTION	DESCRIPTION	BESCHREIBUNG
1	P101015		VITE	SCREW	VIS	SCHRAUBE
2	P2020161	1	CAPOTTINA	ENGINE COVER	COUVERCLE MOTEUR	MOTORABDECKUNG
3		1	MOTORE	ENGINE	MOTEUR	MOTOR
4	P1050011	3	DADO	NUT	ECROU	MUTTER
5	P3120081VE	1	STEGOLA INFERIORE	LOWER HANDLE	GUIDON INFÉRIEUR	HOLMUNTERTEIL
6	P1010153	2	VITE	SCREW	VIS	SCHRAUBE
7	2020060A1	2	POMELLO	KNOB	POIGNÉE	MUTTER
8	1020014A1	4	RONDELLA	WASHER	RONDELLE	SCHIBE
9	P1010120	4	VITE	SCREW	VIS	SCHRAUBE
10	P2020372	4	COPRIMOZZO PER RUOTA	HUB CAP	FLASQUE DE ROUE	RADDECKEL
11	P1010119	4	VITE	SCREW	VIS	SCHRAUBE
12	1020009A1	5	RONDELLA	WASHER	RONDELLE	SCHIBE
13	P3030018	8	CUSCINETTO	BEARING	PALIER	LAGER
14	P000150105	4	RUOTA	WHEEL	ROUE	RAD
15	P1020086	3	RIVETTO	RIVET	RIVET	NIET
16	P4030017ZN	1	CONVOGLIATORE	CONVEYOR	CONVOYEUR	FÖRDERER
17	1090001A1	1	CHIAVETTA	KEY	CLAVETTE	SCHIBENFEDER
18	P3060036VE	1	CHIOCCHIOLA	NUT	ECROU	MUTTER
19	P4010205ZT	1	ANELLO DI RINFORZO	REINFORCEMENT RING	ANNEAU DE RENFORCEMENT	VERSTÄRKUNGSRING
20	P1010101	1	VITE	SCREW	VIS	SCHRAUBE
21	P1010161	2	VITE	SCREW	VIS	SCHRAUBE
22	P1020067	1	RONDELLA	WASHER	RONDELLE	SCHIBE
23	P1010176	1	VITE LAMA	SCREW	VIS	SCHRAUBE
24	P1020080	5	RONDELLA	WASHER	RONDELLE	SCHIBE
25	P1050011	5	DADO	NUT	ECROU	MUTTER
26	P3040287	6	DISTANZIALE	SPACER	ENTRETOISE	DISTANZBÜCHSE
27	1020014A1	4	RONDELLA	WASHER	RONDELLE	SCHIBE
28	P1010175	6	VITE	SCREW	VIS	SCHRAUBE
29	P3060029ZT	1	PORTA RUOTA POST.	REAR WHEEL SUPPORT	SUPPORT ROUE ARRIÈRE	HINTERRADHALTER
30	P5060011	4	TAPPI SOTTOSCOCCA	PLUG	BOUCHON	STÖPSEL
31	P1010187	4	VITE	SCREW	VIS	SCHRAUBE
32	P4080030ZT	2	PIASTRINA	PLATE	PLAQUE	PLATTE
33	P1050011	6	DADO	NUT	ECROU	MUTTER
34	P1020080	6	RONDELLA	WASHER	RONDELLE	SCHIBE
35	P3060034BI	1	VENTOLA	FAN	SOUFFLERIE	GEBLÄSE
36	P1020094	3	RIVETTO	RIVET	RIVET	NIET
37	P2020197	1	COPERCHIO SCOCCA	ADDITIONAL PLUG	FICHE ADDITIONNELLE	STOPFEN
38	P2020201	1	POMELLO	KNOB	POIGNÉE	MUTTER
39	P4070020ZT	1	PROFILO RINF. SCOCCA	REINFORCEMENT BAR	RENFORCEMENT	VERSTÄRKUNG
40	P3100105ZT	1	TONDINO RINF. SCOCCA	REINFORCEMENT STRIP	TRAIT DE RENFORCEMENT	VERSTÄRKUNG
41	P2020205	1	SCOCCA	DECK	CHÂSSIS	GEHÄUSE
42	P3060030ZT	1	PORTA RUOTA POST.	REAR WHEEL SUPPORT	SUPPORT ROUE ARRIÈRE	HINTERRADHALTER
43	1010003A1	2	VITE	SCREW	VIS	SCHRAUBE
44	1020014A1	2	RONDELLA	WASHER	RONDELLE	SCHIBE
45	P4010194ZT	1	SUPPORTO GUIDA ASTA	ROD GUIDE SUPPORT	SUPPORT GUIDE TIGE	FÜHRUNGSHALTER
46	P1050011	2	DADO	NUT	ECROU	MUTTER
47	P3060020ZT	1	ASSALE ANT. COMPLETO	FRONT AXLE SHAFT	ESSIEU AVANT	VORDERACHSE
48	P4010195ZT	1	GUIDA ASTA DI REGOLAZ.	GUIDE	GUIDE	FÜHRUNG
49	P3040296	1	BUSSOLA	BUSHING	DOUILLE	BÜCHSE
50	P3020010	1	MOLLA	SPRING	RESSORT	FEDER
51	P3060033ZT	1	ASTA INF. DI REGOLAZ.	LOWER ADJUSTMENT ROD	TIGE DE RÉGLAGE INF.	STANGENUNTERTEIL
52	P1050021	1	DADO	NUT	ECROU	MUTTER
53	P3100108ZT	1	ASTA SUP. DI REGOLAZ.	UPPER ADJUSTMENT ROD	TIGE DE RÉGLAGE SUP.	STANGENOBERTTEIL
54	P3040290	1	GUIDA ASTA DI REGOLAZ.	ADJ. ROD GUIDE	GUIDE TIGE DE RÉGLAGE	FÜHRUNG
55	P3100106ZT	1	SUPPORTO	SUPPORT	SUPPORT	HALTER
56	P1050014	1	DADO	NUT	ECROU	MUTTER
57	P1050015	1	COPPIGLIA	PIN	GOUPIILLE	STIFT
58	P1010079	2	VITE	SCREW	VIS	SCHRAUBE
59	P3160055	1	SACCO	COLLECTION BAG	SAC DE RAMASSAGE	FANGSACK
60	P2080001	1	RUOTA COMPLETA	WHEEL ASS. Y	ROUE COMPL.	RAD KOMP.
*	IB-2715	1	SACCO ANTIPOLVERE	NO-DUST BAG	SAC ANTIPOUSSIÈRE	STAUBDICHTERSACK

Tav. 2

Vista generale IB-2755 (a trazione)
Complete machine IB-2755 (self-propelled model)
Vue d'ensemble IB-2755 (tracté)
Gesamtansicht IB-2755 (mit Radantrieb)

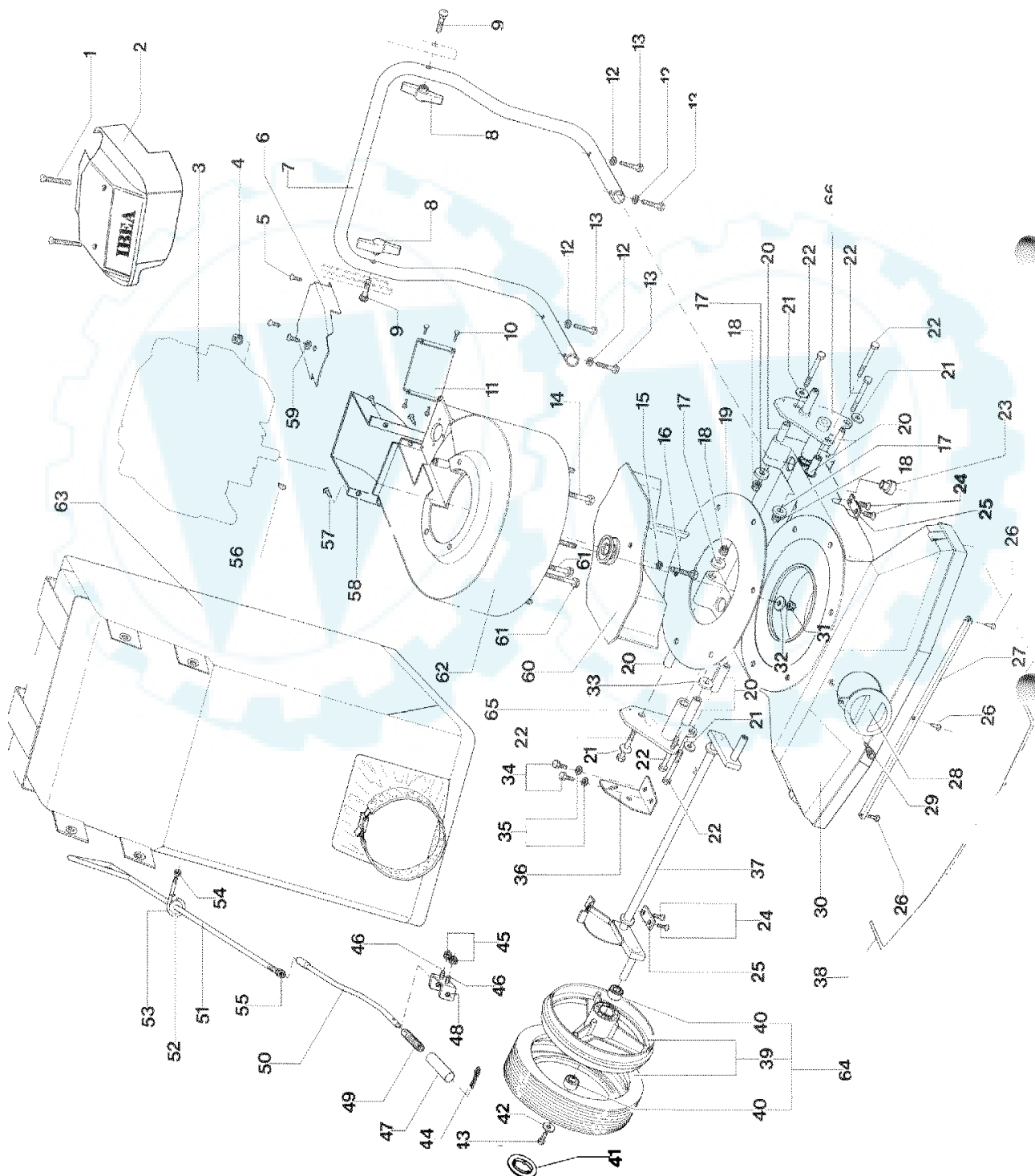

REF. N°	PART. N°	QTY	DESCRIZIONE	DESCRIPTION	DESCRIPTION	BESCHREIBUNG
1	P1010154	2	VITE	SCREW	VIS	SCHRAUBE
2	P2020165	1	CAPOTTINA	ENGINE COVER	COUVERCLE MOTEUR	MOTORABDECKUNG
3		1	MOTORE	ENGINE	MOTEUR	MOTOR
4	P1050011	3	DADO	NUT	ÉCROU	MUTTER
5	P1010018	3	VITE	SCREW	VIS	SCHRAUBE
6	P2020360	1	CARTER COPRICINGHIA	BELT COVER	COUVERCLE DE COURROIRE	KEILRIEMEN
7	P3120081VE	1	STEGOLA INFERIORE	LOWER HANDLE	GUIDON INFÉRIEUR	HOLMUNTERTEIL
8	2020050A1	2	POMELLO	KNOB	POIGNÉE	MUTTER
9	P1010153	2	VITE	SCREW	VIS	SCHRAUBE
10	P1010018	4	VITE	SCREW	VIS	SCHRAUBE
11	P4030025ZT		CARTER	COVER	COUVERCLE	ABDECKUNG
12	1020014A1	4	RONDELLA	WASHER	RONDELLE	SCHIBE
13	P1010120	4	VITE	SCREW	VIS	SCHIBE
14	P1010101	1	VITE	SCREW	VIS	SCHIBE
15	P1020067		RONDELLA	WASHER	RONDELLE	SCHIBE
16	P1010176		VITE LAMA	SCREW	VIS	SCHRAUBE
17	P1020080	5	RONDELLA	WASHER	RONDELLE	SCHIBE
18	P1050011	5	DADO	NUT	ÉCROU	MUTTER
19	P4010205ZT	1	ANELLO DI RINFORZO	REINFORCEMENT RING	ANNEAU DE RENFORCEMENT	VERSTÄRKUNGSRING
20	P3040287	6	DISTANZIALE	SPACER	ENTRETOISE	DISTANZBÜCHSE
21	P1020014A1	4	RONDELLA	WASHER	RONDELLE	SCHIBE
22	P1010175	6	VITE	SCREW	VIS	SCHRAUBE
23	P5060011	4	TAPPI SOTTOSCOCCA	PLUG	BOUCHON	STÖPSEL
24	P1010187	4	VITE	SCREW	VIS	SCHRAUBE
25	P4080030ZT	2	PIASTRINA	PLATE	PLAQUE	PLATTE
26	P1020094	3	RIVETTO	RIVET	RIVET	NIET
27	P4070020ZT		PROFILO RINF. SCOCCA	REINFORCEMENT BAR	REINFORCEMENT	VERSTÄRKUNG
28	P2020197		COPERCHIO SCOCCA	ADDITIONAL PLUG	FICHE ADDITIONNELLE	STOPFEN
29	P2020201		POMELLO	KNOB	POIGNÉE	MUTTER
30	P2020205		SCOCCA	DECK	CHÂSSIS	GEHÄUSE
31	P1050011		DADO	NUT	ÉCROU	MUTTER
32	P1020080		RONDELLA	WASHER	RONDELLE	SCHIBE
33	1020009A1		RONDELLA	WASHER	RONDELLE	SCHIBE
34	1010003A1	2	VITE	SCREW	VIS	SCHRAUBE
35	1020014A1	2	RONDELLA	WASHER	RONDELLE	SCHIBE
36	P4010194ZT	1	SUPPORTO GUIDA ASTA	ROD GUIDE SUPPORT	SUPPORT GUIDE TIGE	FÜHRUNGSHALTER
37	P3060020ZT	1	ASSALE ANT. COMPLETO	FRONT AXLE SHAFT	ESSIEU AVANT	VORDERACHSE
38	P3100105ZT	1	TONDINO RINF. SCOCCA	REINFORCEMENT STRIP	TRAIT DE RENFORCEMENT	VERSTÄRKUNG
39	P000150105	2	RUOTA	WHEEL	ROUE	RAD
40	P3030018	4	CUSCINETTO	BEARING	ROUE	RAD
41	P2020372	2	COPRIMOZZO PER RUOTA	HUB CAP	FLASQUE DE ROUE	RADDECKEL
42	1020009A1	2	RONDELLA	WASHER	RONDELLE	SCHIBE
43	P1010119	2	VITE	SCREW	VIS	SCHRAUBE
44	P1060015	1	COPPIGLIA	PIN	GOUPILLE	STIFT
45	P1050011	2	DADO	NUT	ÉCROU	MUTTER
46	P1010079	2	VITE	SCREW	VIS	SCHRAUBE
47	P3040296	1	BUSSOLA	BUSHING	DOUILLE	BÜCHSE
48	P4010195ZT	1	GUIDA ASTA DI REGOLAZ.	ADJ. ROD GUIDE	GUIDE TIGE DE RÉGLAGE	FÜHRUNG
49	P3020010	1	MOLLA	SPRING	RESSORT	FEDER
50	P3060033ZT	1	ASTA INF. DI REGOLAZ.	LOWER ADJUSTMENT ROD	TIGE DE RÉGLAGE INF.	STANGENUNTERTEIL
51	P3100108ZT	1	ASTA SUP. DI REGOLAZ.	UPPER ADJUSTMENT ROD	TIGE DE RÉGLAGE SUP.	STANGENOBERTTEIL
52	P3040290	1	GUIDA ASTA DI REGOLAZ.	GUIDE	GUIDE	FÜHRUNG
53	P3100106ZT		SUPPORTO	SUPPORT	SUPPORT	HALTER
54	P1050014		DADO	NUT	ÉCROU	MUTTER
55	P1050021		DADO	NUT	ÉCROU	MUTTER
56	1090001A1		CHIAVETTA	KEY	CLAVETTE	SCHIBENFEDER
57	P1020086	3	RIVETTO	RIVET	RIVET	NIET
58	P4030017ZN	1	CONVOGLIATORE	CONVEYOR	CONVOYEUR	FÖRDERER
59	1020007A1	1	RONDELLA	WASHER	RONDELLE	SCHIBE
60	P30600348H		VENTOLA	FAN	SOUFFLERIE	GEBLÄSE
61	P1010164	2	VITE	SCREW	VIS	SCHRAUBE
62	P3060032VE	1	CHIOCCIOLA	NUT	ÉCROU	MUTTER
63	P3160055	1	SACCO	COLLECTION BAG	SAC DE RAMASSAGE	FANGSACK
64	P2080001	2	RUOTA COMPLETA	WHEEL ASS. Y	ROUE COMPL.	RAD KOMP.
65			VEDI TAV. 4	SEE FIG. 4	VOIR TABLE 4	SIEHE BILD 4
66			VEDI TAV. 4	SEE FIG. 4	VOIR TABLE 4	SIEHE BILD 4
*	IB-271U		SACCO ANTIPOLVERE	NO-DUST BAG	SAC ANTIPOUSSIÈRE	STAUBDICHTERSACK

Tav. 3

Stegola superiore e comandi IB-2750 (a spinta)
 Upper handle and controls IB-2750 (push model)
 Mancheron supérieur et éléments de commande IB-2750 (à pousser)
 Lenkeroberteil und Bedienungselemente IB-2750 (handgestoßen)

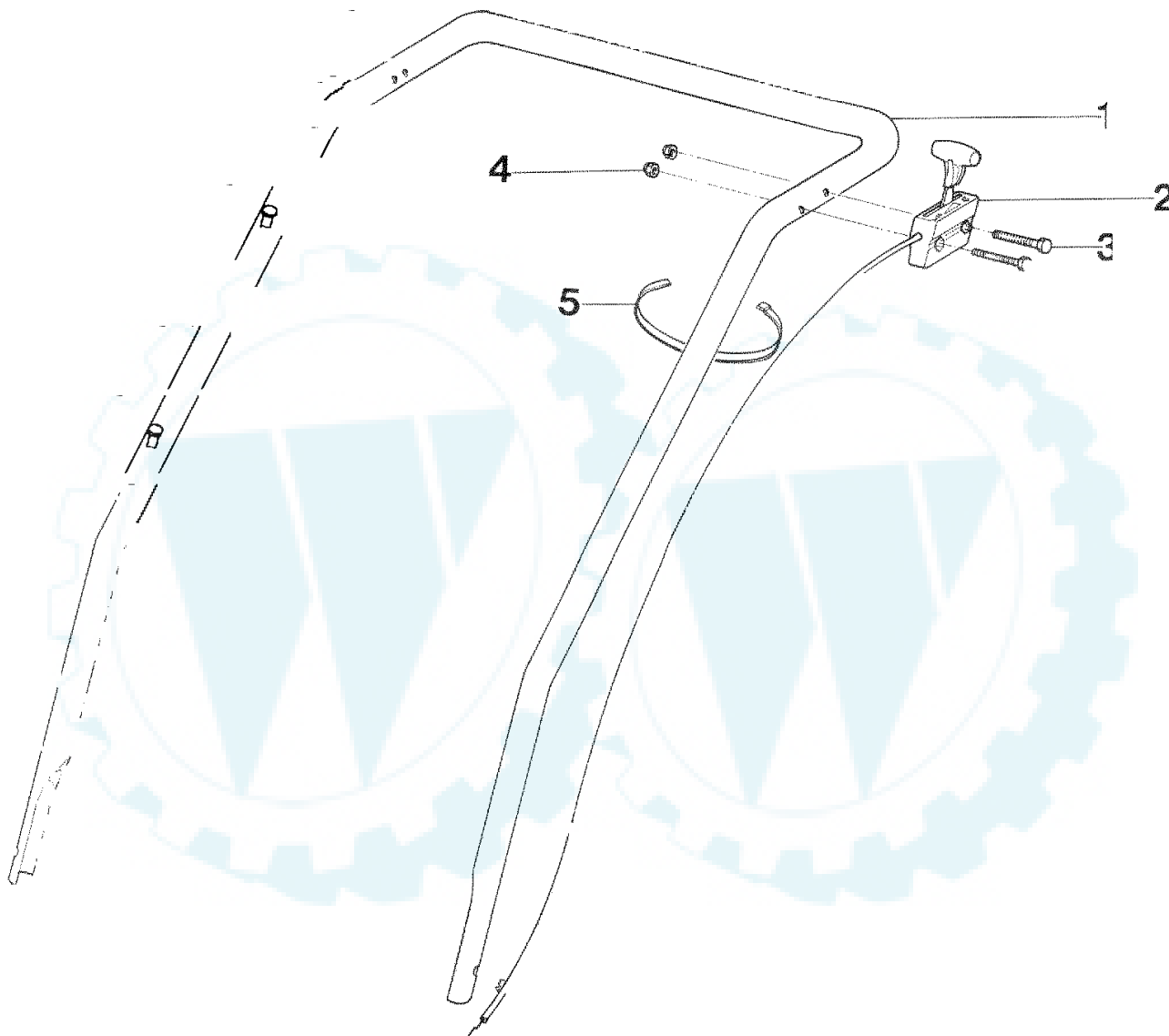

REF. N°	PART. N°	QTY	DESCRIZIONE	DESCRIPTION	DESCRIPTION	BESCHREIBUNG
1	P3120080VE	1	STEGOLA SUPERIORE	UPPER HANDLE	GUIDON SUPERIEUR	OB. FÜHRUNGSHOLM
2	P5020041	1	SCATOLA ACC. + CAVO	THROTTLE HOUSING + CABLE	BOÎTE ET CABLE DE GAZ	GEHÄUSE + GASKABEL
3	P1010160	2	VITE	SCREW	VIS	SCHRAUBE
4	1050003A1	2	DADO	NUT	ÉCROU	MUTTER
5	5040001A1	3	FASCETTA	CLAMP	CLAMP	RAPBAND

Tav. 4

Stegola superiore e comandi IB-2755 (a trazione)
 Upper handle and controls IB-2755 (self-propelled model)
 Mancheron supérieur et éléments de commande IB-2755 (tracté)
 Lenkeroberteil und Bedienungselemente IB-2755 (mit Radantrieb)

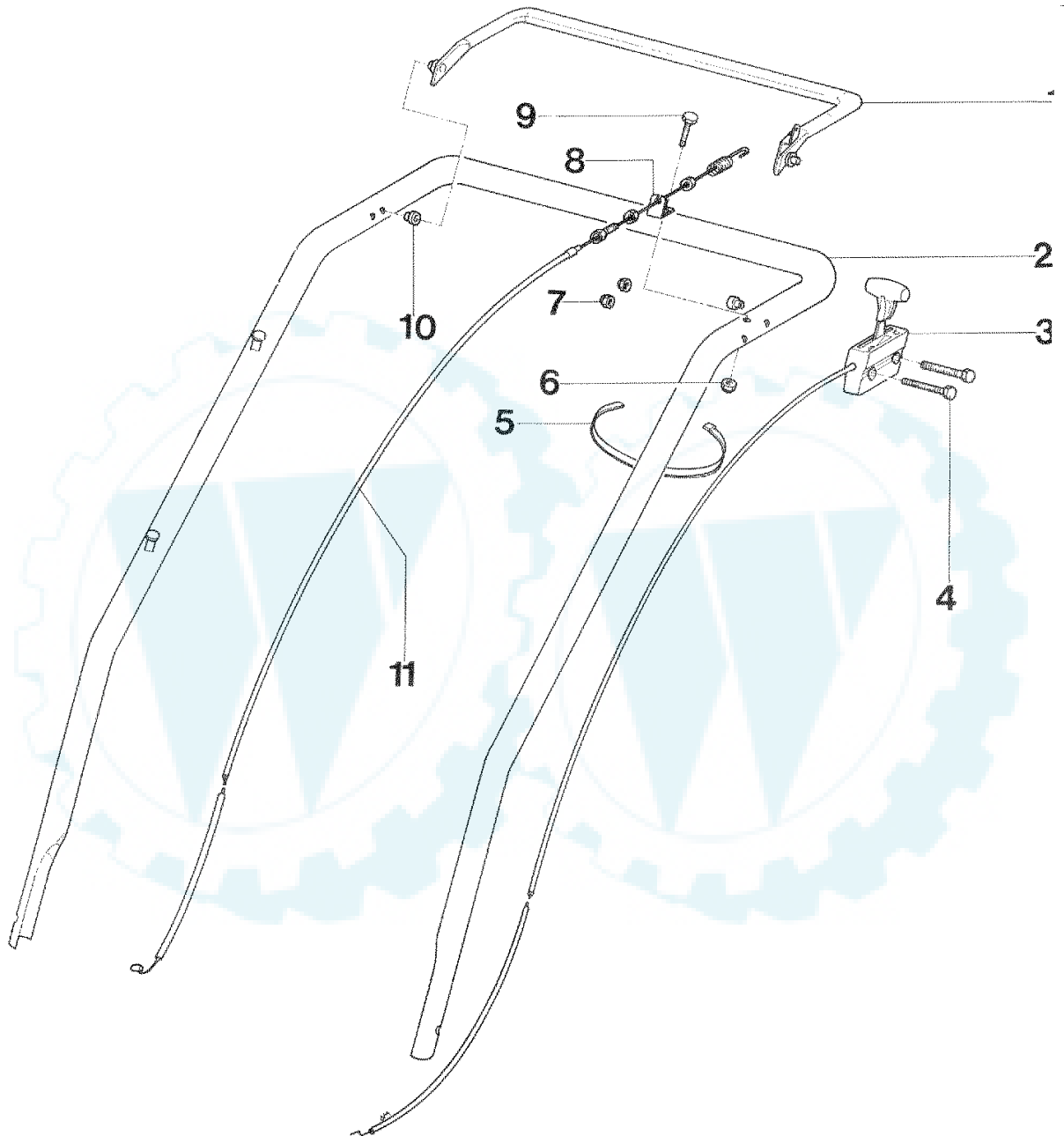

REF. N°	PART. N°	QTY	DESCRIZIONE	DESCRIPTION	DESCRIPTION	BESCHREIBUNG
1	P3060031VE	1	MANIGLIA TRAZIONE	TRACTION LEVER	LEVIER DE TRACTION	ANTRIEBSHEBEL
2	P3120080VE	1	STEGOLA SUPERIORE	UPPER HANDLE	GUIDON SUPERIEUR	OB. FUHRUNGSHOLM
3	P5020041	1	SCATOLA ACC. + CAVO	THROTTLE HOUSING + CABLE	BOÎTE ET CABLE DE GAZ	GERÄUSE + GASKABEL
4	P1010160	2	VITE	SCREW	VIS	SCHRAUBE
5	5040001A1	3	FASCETTA	CLAMP	CLAMP	RAPBAND
6	1050003A1	1	DADO	NUT	ÉCROU	MUTTER
7	1050003A1	2	DADO	NUT	ÉCROU	MUTTER
8	P4010060	1	PIASTRINA	PLATE	PLAQUE	PLATE
9	P1010163	1	VITE	SCREW	VIS	SCHRAUBE
10	P3040123	2	BUSSOLA	BUSHING	DOUILLE	BÜCHSE
11	P5010044	1	CAVO TRAZIONE	TRACTION CABLE	CABLE DE TRACTION	ANTRIEBSKABEL

T

Vista le te mission IB-2755 trazioni
Rea xl an gear B-27 r-propelled model)
Ess riè el mi (tracté)
H ract no ah riebe B-27 (mit Rad rieb

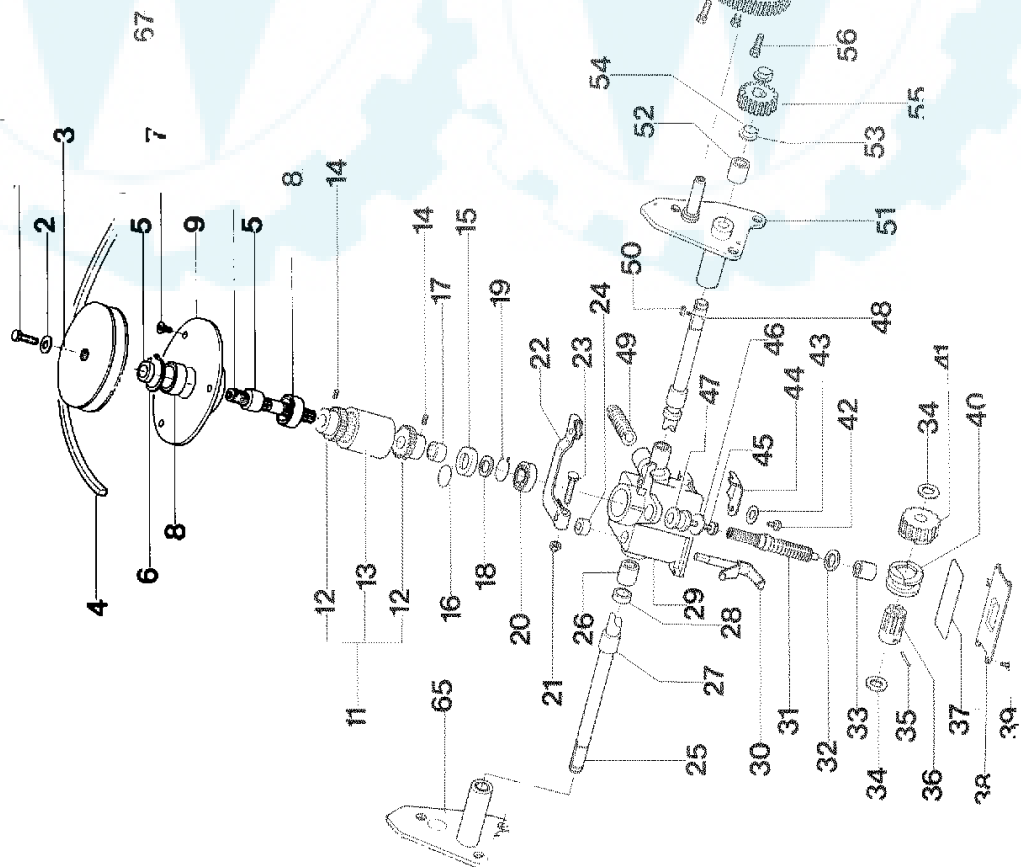
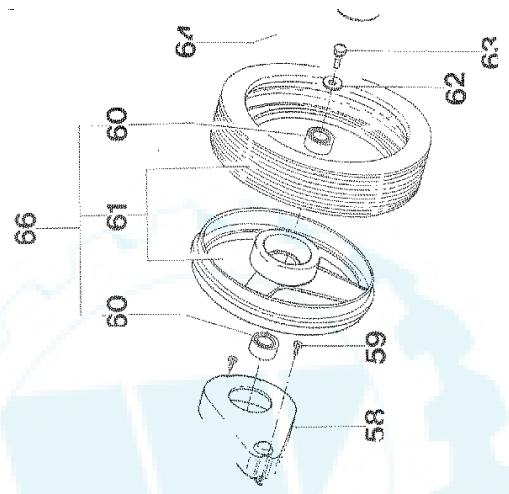
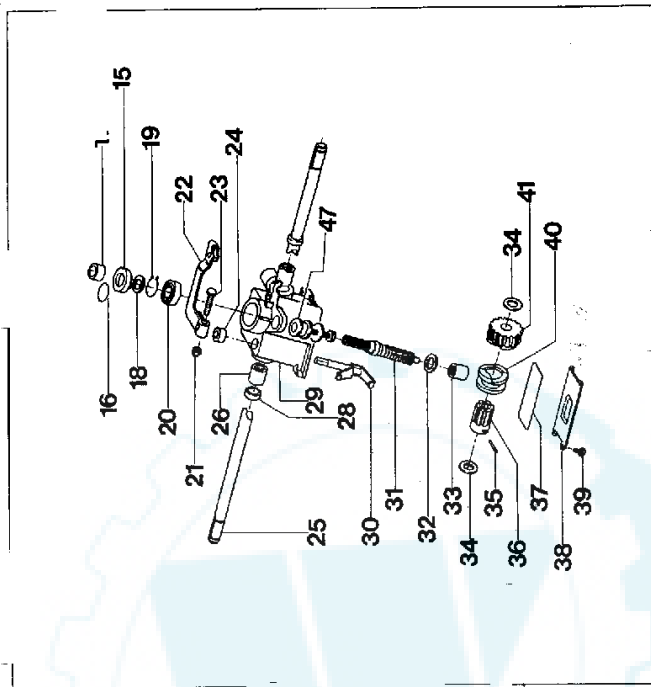

REF. N°	PART. N°	QTY	DESCRIZIONE	DESCRIPTION	DESCRIPTION	BESCHREIBUNG
1	1010018A1	1	VITE	SCREW	VIS	SCHRAUBE
2	1020007A1	1	RONDELLA	WASHER	RONDELLE	SCHEIBE
3	P3040276	1	PULEGGIA	PULLEY	POULIE	SCHEIBE
4	P3010022	1	CINGHIA	BELT	COURROIE	RIEMEN
5	P3040285	2	DISTANZIALE	SPACER	ENTRETOISE	DISTANZBÜCHSE
6	P1070013	1	SEEGER	SPACER	DOUILLE	DISTANZBÜCHSE
7	P1010202	3	VITE	SCREW	VIS	SCHRAUBE
8	P3030023	2	CUSCINETTO	BEARING	ROUE	RAD
9	P3040278	1	BUSSOLA	BUSHING	DOUILLE	BÜCHSE
10	P3040277BR	1	ALBERO	SHAFT	ARBRE	WELLE
11	P3050028	1	GIUNTO	JOINT	JOINT	KUPPLUNG
12	P3040275	2	MOZZO	HUB	MOYEU	RADNABE
13	P1040002	1	MANICOTTO	COUPLING	MANCHON	MUFFE
14	P1130005	2	GRANO	DOWEL	CHEVILLE	DÜBEL
15	P31700010	1	ANELLO DI TENUTA	OIL SEAL	JOINT D'ARBRE	WELLENDICHTRING
16	P3170013	1	O-RING	SPACER	DOUILLE	ABSTANDSSTÜCK
17	P3040049	1	BUSSOLA	BUSHING	DOUILLE	BÜCHSE
18	P1020051	1	RONDELLA	WASHER	RONDELLE	SCHEIBE
19	P1070004	1	SEEGER	CIRCLIP	SEEGER	SEEGER
20	P3030010	1	CUSCINETTO	BEARING	PALIER	LAGER
21	1050003A1	1	DADO	NUT	ÉCROU	MUTTER
22	P4070011	1	LEVA TRAZIONE	LEVER	LEVIER	HEBEL
23	P1010075	1	VITE	SCREW	VIS	SCHRAUBE
24	P3170012	1	ANELLO DI TENUTA	OIL SEAL	JOINT D'ARBRE	WELLENDICHTRING
25	P3040284	1	ALBERO DI TRASMISSIONE	TRANSMISSION SHAFT	ARBRE DE TRANSMISSION	ANTRIEBSWELLE
26	P3030020	2	CUSCINETTO	BEARING	PALIER	LAGER
27	3030003A1	2	CUSCINETTO	BEARING	PALIER	LAGER
28	P3170011	2	ANELLO DI TENUTA	OIL SEAL	JOINT D'ARBRE	WELLENDICHTRING
29	P00039152	1	SCATOLA RIDUTTORE	GEARBOX	BOÎTE DE VITESSE	GETRIEBE
30	P3040041	1	FORCELLA INNESTO	FORK	FOURCHE	GABEL
31	P3040114	1	VITE SENZA FINE	WORM GEAR	VIS SANS FIN	SCHRAUBE OHNE ENDE
32	P1020053	1	RONDELLA	SPACER	DOUILLE	ABSTANDSSTÜCK
33	P3030019	1	CUSCINETTO	BEARING	PALIER	LAGER
34	1020020A1	2	RONDELLA	WASHER	RONDELLE	SCHEIBE
35	P1080013	1	SPINA	PIN	GOUPILLE	STIFT
36	P00065452	1	BUSSOLA	BUSHING	DOUILLE	BÜCHSE
37	P3170014	1	O-RING	O-RING	JOINT TORIQUE	GUMMIRING
38	P4110001	1	COPERCHIO	COVER	COUVERCLE	DECKEL
39	P1010076	4	VITE	SCREW	VIS	SCHRAUBE
40	P00037952	1	INNESTO	SELECTOR COLLAR	MANCHON	SCHALTBÜCHSE
41	P00038252	1	RUOTA ELICOIDALE	GEAR	ENGRANAGE	STIRNRAD
42	P1010076	1	VITE	SCREW	VIS	SCHRAUBE
43	P1020055	1	RONDELLA	WASHER	RONDELLE	SCHEIBE
44	P4030010	1	COPERCHIETTO	COVER	COUVERCLE	DECKEL
45	P1010173	1	VITE	SCREW	VIS	SCHRAUBE
46	P1020054	1	RONDELLA	WASHER	RONDELLE	SCHEIBE
47	P2040010	1	ANTIVIBBRANTE	RUBBER TUBE	TUBE DE PROTECTION	SCHUTZHUELLE
48	P3020019	2	MOLLA	SPRING	RESSORT	FEDER
49	P3020010	1	MOLLA	SPRING	RESSORT	FEDER
50	P1090005	2	CHIAVETTA	SPLINE	CLAVETTE	SCHEIBENFEDER
51	P3060027ZT	1	PORTA RUOTA POST.	REAR WHEEL SUPPORT	SUPPORT ROUE ARRIÈRE	HINTERRADHALTER
52	3030003A1	4	CUSCINETTO	BEARING	PALIER	LAGER
53	1020020A1	4	RONDELLA	WASHER	RONDELLE	SCHEIBE
54	1070001A1	4	SEEGER	CIRCLIP	SEEGER	SEEGER
55	P3050034	2	PIGNONE	PINION	PIGNON	RITZEL
56	P1010199	6	VITE	SCREW	VIS	SCHRAUBE
57	P3050049	2	INGRANAGGIO	GEAR	ENGRANAGE	STIRNRAD
58	P4030018ZT	2	CARTER	COVER	COUVERCLE	ABDECKUNG
59	P1010018	4	VITE	SCREW	VIS	SCHRAUBE
60	P3030018	4	CUSCINETTO	BEARING	PALIER	LAGER
61	P000150105	2	RUOTA	WHEEL	ROUE	RAD
62	1020020A1	2	RONDELLA	WASHER	RONDELLE	SCHEIBE
63	P1010119	2	VITE	SCREW	VIS	SCHRAUBE
64	P2020372	2	COPRIMOZZO PER RUOTA	HUB CAP	FLASQUE DE ROUE	RADDECKEL
65	P3060026ZT	1	PORTA RUOTA POST.	REAR WHEEL SUPPORT	SUPPORT DE ROUE ARRIÈRE	HINTERRADHALTER
66	P2080001	2	RUOTA COMPLETA	WHEEL ASS. Y	ROUE COMPL.	RAD KOMP.
67	P3060035	1	RIDUTTORE COMPL.	GEARBOX ASS. Y	TRANSMISSION COMPL.	FAHRGETRIEBE KOMP.

Tav. 1

Vista generale IB-2750 (a spinta)
Complete machine IB-2750 (push model)
Vue d'ensemble IB-2750 (à pousser)
Gesamtansicht IB-2750 (handgestoßen)

